

VK-45 LOUVRE SHUTTER

Item no. 5645

Document type: **Product card**
 Document date: **2013-10-15**
 Generated by: **Systemair Online Catalogue**

Description

Louvre shutter

Louvre shutters for vertical mounting on a wall. The profiled vanes produce a strong upward force which reduces the air resistance. This means that the vanes opens fully at low air velocities as well.

All the parts are manufactured in weather-resistant and shockproof nylon material (PVC containing special synthetic). The robust construction ensures that the vanes will not become deformed or loose.

Above size 45, the vanes are fitted with a cast counterweight. Air velocity should not exceed 12 m/s. Maximum allowed temperature is 60 °C. The louvre shutters are easy to install. Wall plugs and screws are included above size 15.



Performance data

...

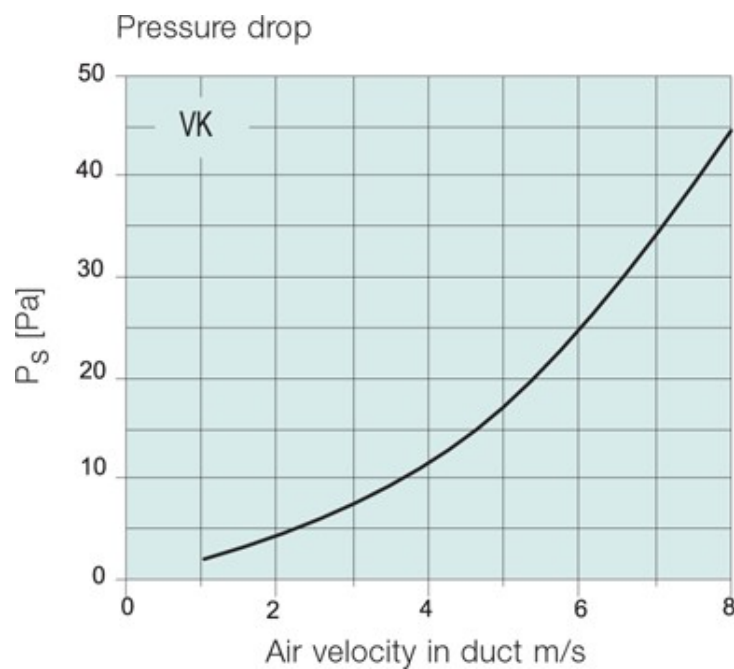

Dimensions

	A	B	C	D	E	F	G
VK 10	142	15	103	96	5	46	3
VK 12	164	12	115	117	5	38	4
VK 15	178	20	130	152	4	50	5
VK 20	245	20	190	210	5	50	6
VK 25	299	25	235	260	5	70	5
VK 30	347	26	274	310	5	70	6
VK 35	397	26	310	360	5	70	7
VK 40	460	26	364	423	5	65	8
VK 45	501	31	395	460	5	70	6
VK 50	549	31	445	510	5	95	7
VK 56*	610	30	530	530	5	80	14(2x7)
VK 63*	701	31	626	660	5	85	16(2x8)
VK 71*	749	31	663	710	5	90	18(2x9)

G = amount of fins

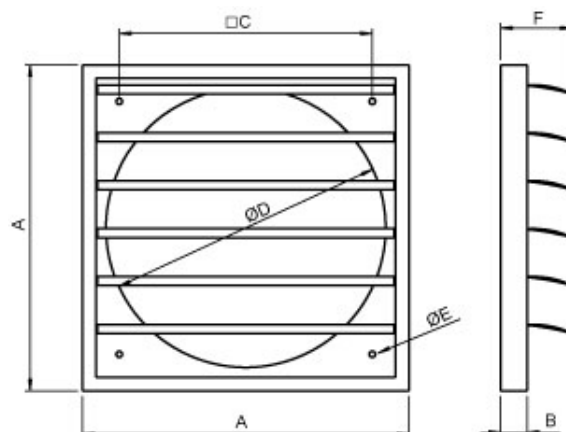

* side by side shutters