

Aura eco 150

Larger bathroom, utility room and kitchen ventilation (adjacent to hob)

Key Features



- Axial fan
- Ventilation up to 235 m³/hr
- Slim compact styling
- Quick and easy to fit
- Quiet - 35 dB(A)
- Low watt motor - 20w
- Low SFP - 0.31 W/l/s
- Compatible with 150mm ducting
- IPX4 rating
- Complies with Building Regulations
- 3 year warranty



Aura eco 150 range

Highly reliable, low energy fan in a modular design for ease of installation and maintenance. The Aura eco 150 is designed to provide quiet extraction in a suitable application.

The fan comes in various control options and is recessed into the wall or ceiling. The Aura range of fans are slim, compact, attractively styled, are easy to wipe clean and can be ducted over short lengths.



Models

Basic	Control by Remote Switch
Timer	Timer can be set to run on between 2 and 30 minutes
Humidity Timer	Humidity sensor can be set between 60 - 90% RH
Motion Sensor Timer	PIR sensor activates the fan



Technical Data

Specification	Aura eco 150B	Aura eco 150T	Aura eco 150HT	Aura eco 150MST
Air flow m³/hr / l/sec	235 / 65	235 / 65	235 / 65	235 / 65
Fan type	Axial	Axial	Axial	Axial
Controls	Basic	Timer	Humidity Timer	Motion Sensor Timer
Mounting	Wall / Ceiling	Wall / Ceiling	Wall / Ceiling	Wall / Ceiling
Sound pressure dB(A)@3m	35	35	35	35
Power watts	20	20	20	20
Amps	0.14	0.14	0.14	0.14
Specific Fan Power (SFP)	0.31	0.31	0.31	0.31
Duct diameter (mm)	150	150	150	150
Voltage	230v / 1ph / 50-60Hz	230v / 1ph / 50-60Hz	230v / 1ph / 50-60Hz	230v / 1ph / 50-60Hz
Rating	IPX4	IPX4	IPX4	IPX4
Material finish	Plastic	Plastic	Plastic	Plastic
Weight (kg)	0.9	0.9	0.9	0.9
Dimensions (H x W x D) mm	205 x 205 x 124	205 x 205 x 124	205 x 205 x 124	205 x 205 x 124
Part No.	9041351	9041352	9041353	9041354

Dimensions (mm)

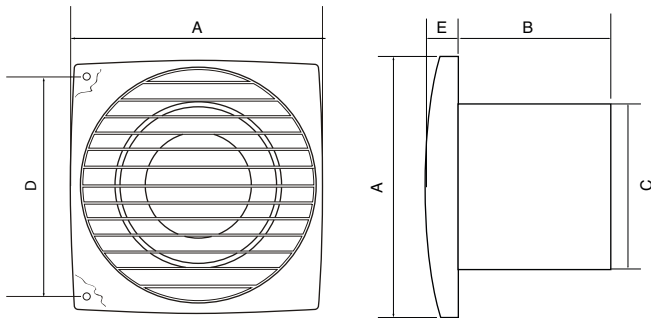

Model	A	B	C	D	E
Aura eco 150	205	124	150	174	19

Performance

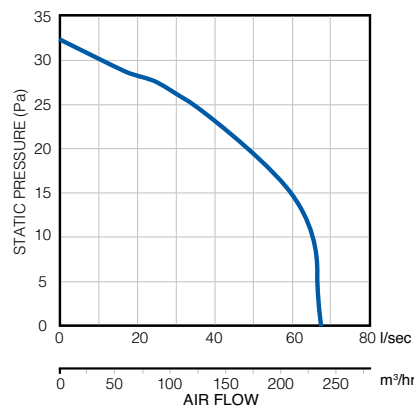

Controls and Accessories

A range of accessories including flexible and rigid ducting kits, controls, switches and grilles are available.

Call: 01494 560800

Visit: airflow.com



Airflow Developments Limited
Aidelle House, Lancaster Road,
Cressex Business Park,
High Wycombe, Buckinghamshire,
United Kingdom, HP12 3QP

E-mail: info@airflow.com
Telephone: +44 (0) 1494 525252

airflow.com

© Airflow Developments Limited. Airflow Developments Limited reserve the right, in the interests of continuous development, to alter specifications without prior notice. All orders are accepted subject to our conditions of sale which are available on request.

