

MUB/T 062 630D4 IE2

Item no. 33660

Description

- Up to 120°C medium temperature, continuous operation
- Multi-functional use, e.g. for kitchen exhaust air
- Modular system
- Pre-assembled isolator is standard
- Low sound level
- Easy to maintain and reliable
- High efficient IE2 motors
- Speed-controllable via frequency converter
- Motor outside the air stream



All MUB/T fans have impellers with backward curved blades, manufactured from aluminium, and IEC standard motors outside the air stream with efficiency class IE2 for all 400V three phase motors from 0.75 kW. The MUB/T fans are suitable for medium temperatures up to 120°C continuously. Motor protection by cold conductors or thermal contact, to be connected to an external motor protection device.

The casing consists of an aluminium frame with fibreglass reinforced plastic corners and double skin, galvanised steel panels with a 20 mm mineral wool insulation.

Panels are removable, allowing flexible ventilation solutions - the air direction can easily be changed. With quick lock access door. The MUB bottom panel is shaped as a condensate tray and incorporates a pre-mounted 1" drain plug. An isolator switch is mounted on the casing.

Several filter modules like f.e. activated carbon- or aluminum filters are available, calculated individually on the working point.

Please note: Speed control by voltage, i.e. voltage transformers, is not possible!

In accordance with Commission Regulation (EC) no 640/2009 of the European Parliament - eco-design requirements for electric motors - the new international efficiency classes are binding as of 16 June 2011. These guidelines defined by CEMEP and EPACT are regarded as international standard for energy-saving high-efficiency motors for frequencies of 50 or 60 Hz and make the use of IE2 motors mandatory.

With this new and more efficient technology we offer our customers many advantages such as environmentally friendly operation, reduced energy consumption and hence lower emissions. IE2 motors have a higher efficiency even in part load operation and allow optimum adjustment to the operating point. In addition, the IE2 motors generate less noise and develop less heat, which has a positive influence on the efficiency and the cooling requirement of the motor. Please note: IE2 motors cannot be speed controlled by voltage, i.e. voltage transformers.

Technical parameters

Nominal data		
Voltage	400	V
Frequency	50	Hz
Phase	3	~
Input power (P1)	4505	W
Current	7,54	A
Max. airflow	14681	m³/h
Fan impeller speed	1452	r.p.m.
Weight	102	kg
Temperature data		
Max. temperature of transported air	120	°C
Sound data		
Sound pressure level at 3 m (20m² Sabin)	74,9	dB(A)

Protection / Classification	
Insulation class	F
Enclosure class, motor	IP55
Default group	
Starting current	60,9 A

Performance

Diagrams

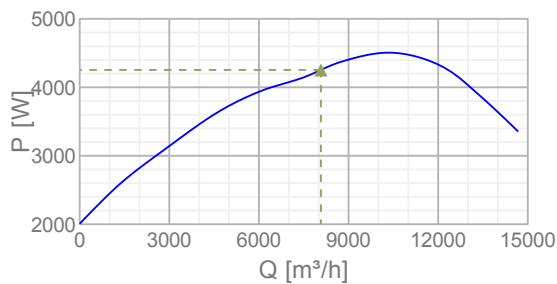
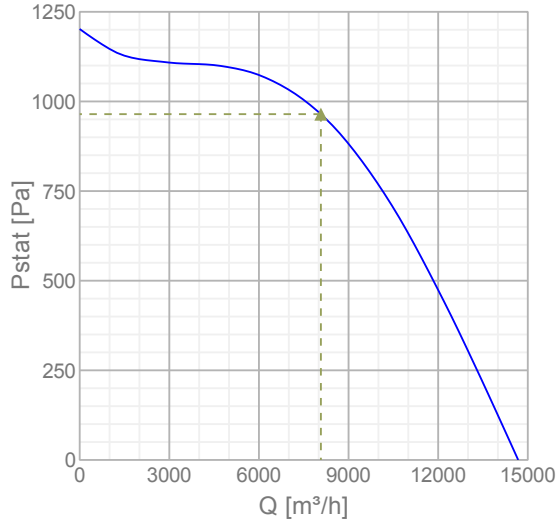

Max efficiency

Hydraulic data										
▲ Working air flow										8073 m³/h
▲ Working static pressure										965 Pa
▲ Power										4254 W
Speed										1454 r.p.m.
Current										7,21 A
SFP										1,9 kW/(m³/s)
Voltage										400 V
Sound power level		63	125	250	500	1k	2k	4k	8k	Tot
Inlet	dB(A)	57	81	77	80	80	77	74	66	87
Outlet	dB(A)	59	83	78	81	82	78	75	68	88
Surrounding	dB(A)	52	73	66	65	61	63	63	54	75

Dimensions

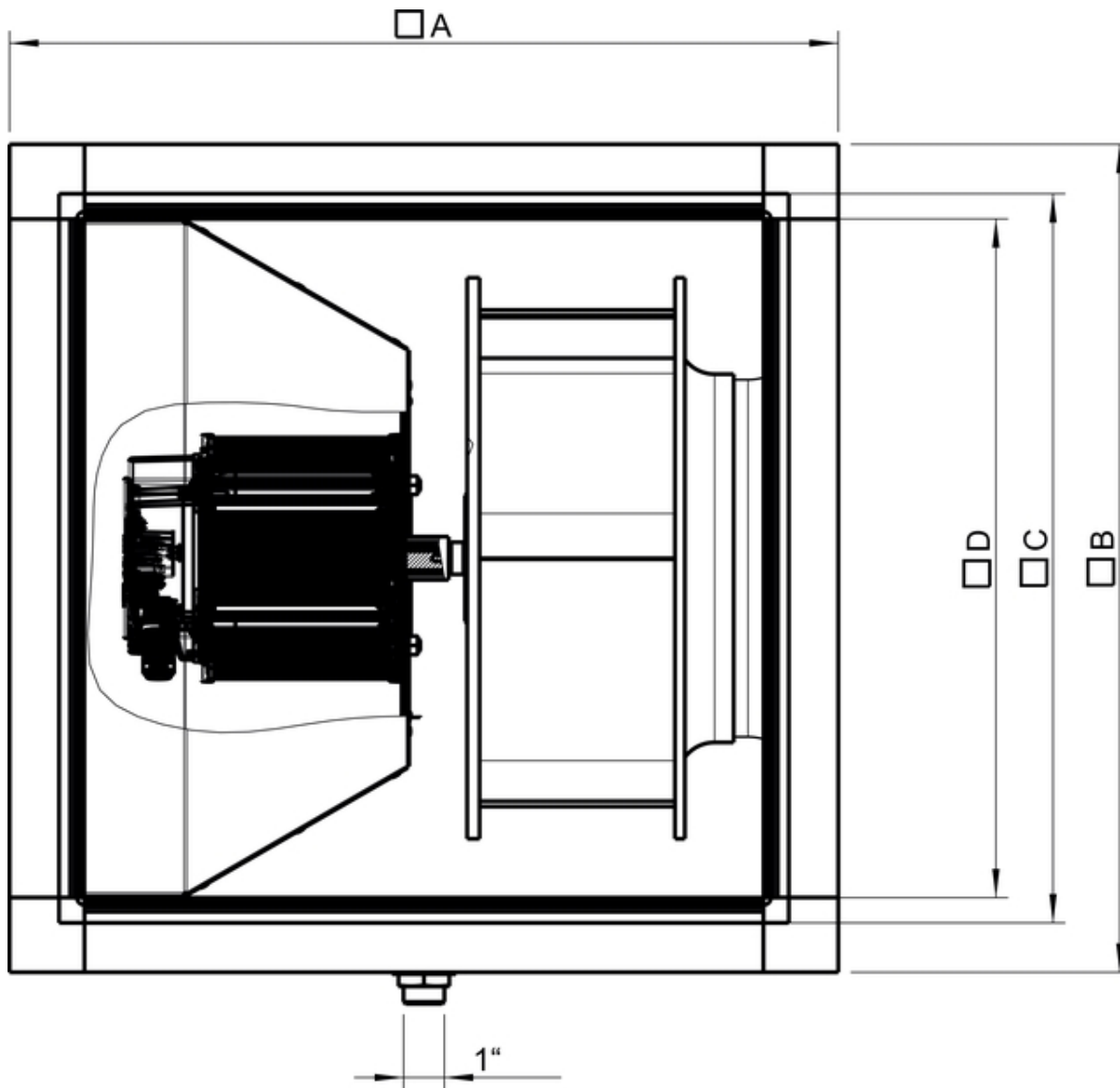

□A	□B	□C	□D
MUB/T 062 630	800	800	720 678

Wiring

Dreiphasenmotor mit Kaltleiter Three phase motor with cold conductor Moteur triphasé avec résistance PTC

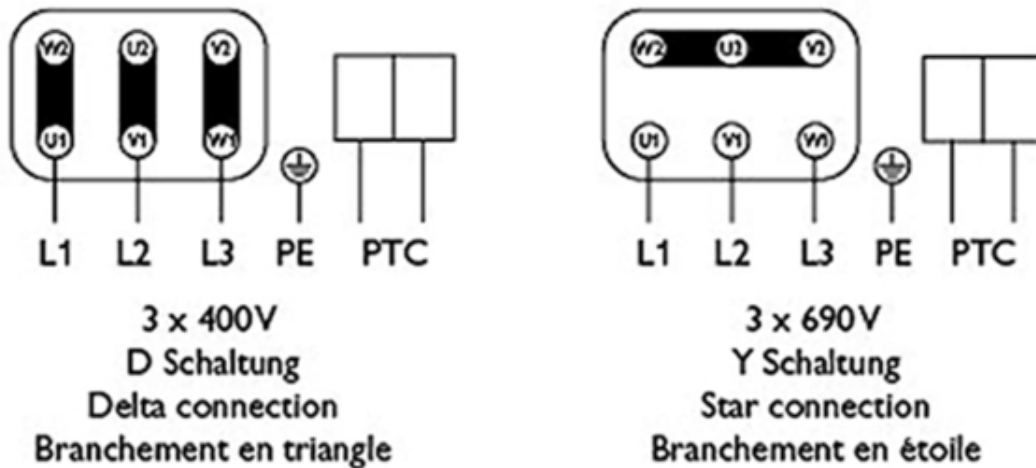

Drehrichtungsänderung durch Vertauschen von 2 Phasen
Changing of direction of rotation by interchanging of two phases
Changement de sens de rotation par inversion de deux phases

Typenschild beachten! See label! Voir plaque!

Accessories

Electric accessories

- [U-EK230E Motor protection \(30199\)](#)
- [FXDM14AM Frequency inv. IP54 \(31389\)](#)
- [FRQ5S-10A+LED V2 \(36234\)](#)
- [FRQ5-10A+LED V2 \(36230\)](#)
- [FRQS-10A V2 \(36232\)](#)
- [FRQ-10A V2 \(36228\)](#)

Accessories

- [FGV 062/716-716 flex. conn. \(4198\)](#)
- [UGS 062/630 adapter flex. \(4358\)](#)
- [WSD 062 \(860x860x70\) complete \(31482\)](#)
- [SDM Service Door MUB 062 comp. \(32573\)](#)
- [CCM outlet MUB062 d630 \(311681\)](#)
- [CCM outlet MUB062 d560 \(311684\)](#)
- [CCM inlet MUB062 d560 \(311782\)](#)
- [CCM inlet MUB062 d630 \(311783\)](#)
- [M-SG 062/718x718 \(301346\)](#)
- [WSG 062 MUB/T complete \(36067\)](#)
- [SD-MUB Vibration pad set \(37324\)](#)
- [CCMI outlet 062 d560 insul KIT \(313847\)](#)
- [CCMI outlet 062 d630 insul KIT \(313848\)](#)
- [FGV 062/716-716 flex. 120°C \(38362\)](#)
- [UGS 062/500 adapter flex 120°C \(38370\)](#)
- [UGS 062/630 adapter flex 120°C \(38371\)](#)
- [TUNE-AHU-DE008-062-718x718-M0 \(79882\)](#)

Documentation

 [manual_mub_all_en_\[008\].pdf \(2,29MB\)](#)

 eu declaration of conformity_thermofans_en_[002].pdf (46,39kB)

 Commissioning Report_fans_160628_en_001.pdf (42,79kB)

Specification text

Multibox Thermo fan for medium temperatures up to 120 °C in continuous operation, reliable, for easy and direct installation in duct systems. Casing frame construction made of aluminium hollow profiles and plastic corners for highest impact resistance. Double skin galvanised steel panels, thermally and sound insulated with a 20 mm layer of mineral wool, smooth inner sides. Removable service panel. Bottom panel is shaped as a condensate tray and incorporates a pre-mounted 1" drain plug. Free-running, backward curved circular impeller made of aluminium. Impeller acc. to VDI 2060, balancing quality Q 6.3, dynamically balanced in two planes acc. to ISO 1940 T1. Internal rotor motor, frequency inverter control, standard motor IE2 (IP54), outside the air flow. Integral thermal contacts with leads to a motor protection device. Terminal box fitted on the motor. Pre-assembled isolator switch. Multifunctional use, square connection, intake and discharge side. Variable outlet direction, can be modified on site. Suitable for kitchen exhaust. Horizontal installation position only. For indoor installation. For outdoor installation with corresponding accessories.